

SCREW IN, 3-WAY SOLENOID OPERATED DIRECTIONAL VALVE CAVITY 3/4" 16 UNF-SAE 08/3

EV*3*-34-*

20 l/min 25 MPa (250 bar)

1 DESCRIPTION

Directional control valve 3 way 2 position spool type.
Is possible to have this valve in two different version, light line and high performance.
Light line version is available with plastic coils and metallic coils.
High performance version is available only with metallic coils.
The dual seals rings assure an efficient and reliable tightness of the valve.



2 ORDERING CODE

(1)	(2)	(3)	(4)	(5)	(6)	(7)	(8)	(9)
EV		3	-	34	-	-	-	-

(1) EV : 3-way solenoid operated spool type

(2) valve type
L: Light line
H: High line

(3) three way valve

(4) Spool type
C: normally closed
O: normally open

(5) 34: cavity 3/4" 16 UNF

(6) Valves variants (see 6)
03: without manual override
04: manual override push type (standard)
05: manual override screw type

(7) Electric voltage and solenoid coils (see 3, see 8)
0000 : no coil
012C : coil for V12DC
024C : coil for V24DC
220R : coil for V220-230 RAC

(8) Options for coil connection (see 8)
no designation : standard connection ISO4400/DIN43650/A
C flying leads
D:Deutsch
A: AMP Junior

(9) Options for ISO4400/DIN 43650/A connectors (see 7)
B9: standard connector, black PG9
D9: black connector, with diode, PG9
ES: "energy saving" connector with LED
R*: rectifier bridge; L*:LED; V*:LED+varistor

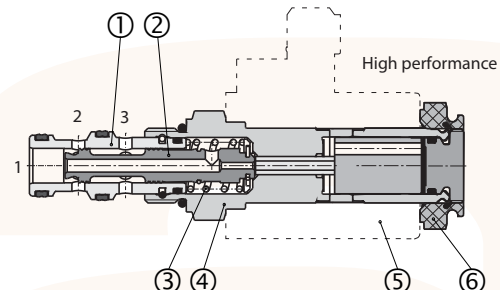
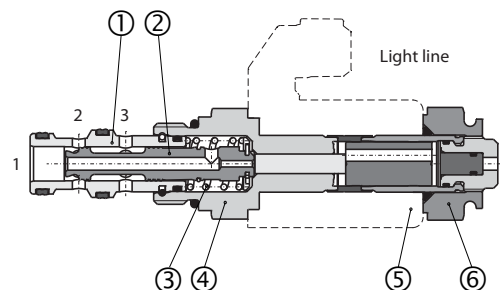
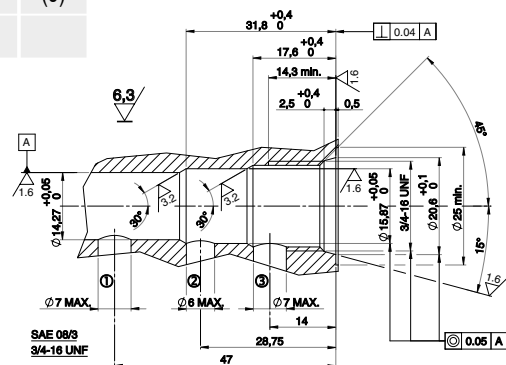
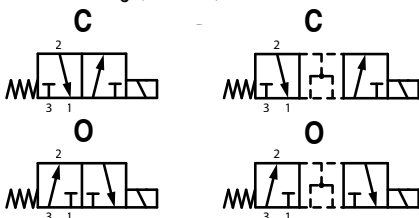

Screw-in 3/2 solenoid valves type EV3*.34 are composed by a valve sleeve 1, a control spool 2, a return spring 3, and an actuating assembly 4 that comprises the magnetic parts and the screwing section. An energizing electric solenoid coil 5 is fastened to the assembly by means of a retaining nut 6. When solenoid coils is energized, a magnetic mobile armature shifts and by means of a rod installed inside assembly, moves the control spool which makes hydraulic connections between 1,2,3 ports.

3 TECHNICAL DATA

Max. nominal pressure	25 MPa (250 bar)	Electric Characteristics:
Nominal flow rate	16 l/min	Those solenoid valves are normally equipped by coils type C36, which are energized from DC or AC supply. Coils type C36-***C are DC energized directly from a V***DC supply. Coils type C36-***R are RAC (Rectified Alternate Current) energized from a V***AC supply, by a full wave bridge rectifier incorporated in the connector. Coils type C36 are normally provided for use of ISO 4400/DIN 43650/A connectors. For coils with different connection to the power supply, see table C30/36.
Max. rec. flow rate	20 l/min	
Dimension and installation	see 4	
Duty cycle	ED100%	
Mass (without coil)	0,20 kg	

4 INSTALLATION DIMENSIONS (mm)

Light line

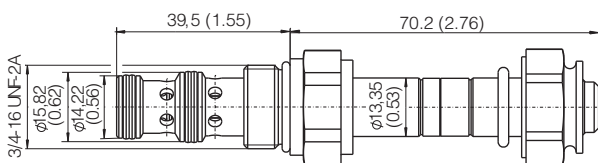

High performance

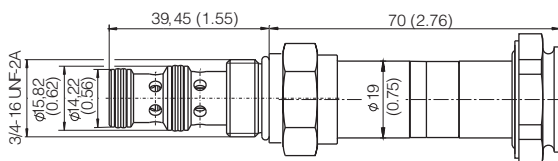

EV3*.34 valves are to be installed in cavity 3/4" 16 UNF. Check the appropriate state and position of the seals, screw the valve in the cavity and lock it with a torque of about 45 Nm applied on the 24 mm hexagon.

5 TYPICAL DIAGRAMS

Hydraulic limits of use High performance valve

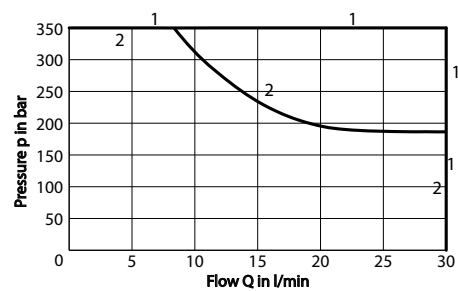

1 Normally closed (C) 3→2
Normally closed (C) 2→1

2 Normally open (O) 2→1
Normally open (O) 3→2

Hydraulic limits of use Light line valve

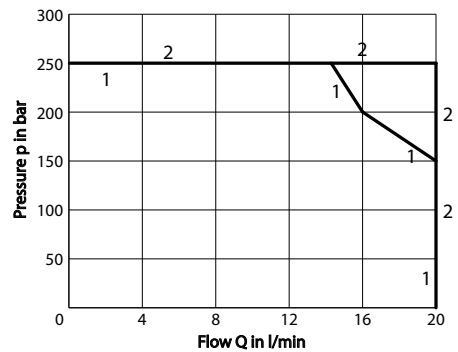

1 Normally open (O) 3→2

2 Normally open (O) 2→1
Normally closed (C) 2→1
Normally closed (C) 3→2

6 VARIANTS OF MANUAL OVERRIDE

04: Manual override push type (standard)

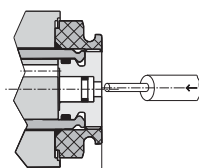

Standard valve: 64,5
High performance valve: 70

05: Manual override screw type

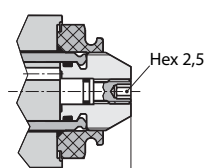

Standard valve: 71,5
High performance valve: 77,5

7 CONNECTORS

Standard coils are compatible with KA-132 connectors (see table); for some functions (R* = bridge rectifier, L* = LED, etc.) the voltage has to be specified :

1 = V12, V24 2 = V115 3 = V230

The "energy saving" connectors – option ES – save current consumption to less than 50% of the nominal and strongly reduce warming up of the coils.

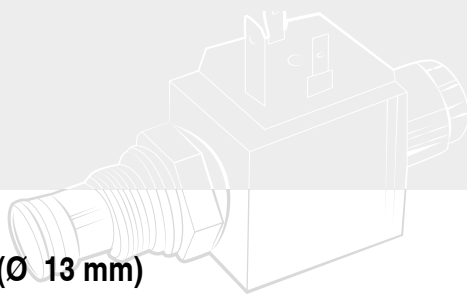

8 COILS type C36 (Ø 13 mm)

Coils DIN	voltage DC	nominal current (A)	resistance 20° C (Ω)	nominal power (W)	insulation class
C36L-012C	V 12 DC	1,9	6,3	22,8	H
C36L-024C	V 24 DC	0,95	25,6	22,5	
C36L-024R	V 24 RAC	1,05	20,2	23	
C36L-048C	V 48 DC	0,47	102	22,6	
C36L-110R	V 110-115 RAC	0,23	420	22,9	
C36L-220R	V 220-230 RAC	0,11	1720	22,3	

CONNECTION OPTIONS

DIN 4365/A-ISO 4400 DEUTSCH FLYING LEADS AMP JUNIOR

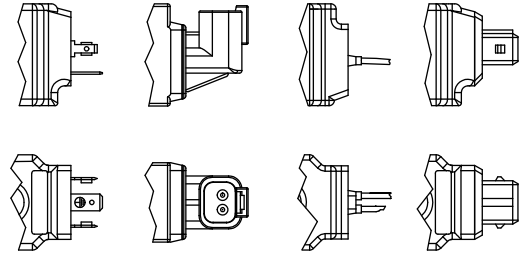

9 COILS type B02 (Ø 19 mm) FOR EVH

Coils DIN	voltage (V)	nominal current (A)	resistance 20° C (Ω)	nominal power (W)	insulation class
B02-012C	V 12 DC	2,45	4,9	29	H
B02-024C	V 24 DC	1,15	20,8	28	
B02-110R	V 110-115 RAC	0,24	433	28	
B02-220R	V 220-230 RAC	0,12	1653	28	

C36L

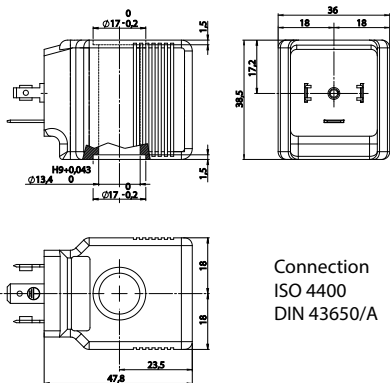

B02

DIN 43650/A

AMP

AMPX

DEUTSCH

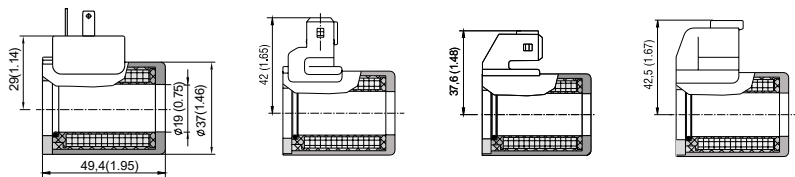

FLYING LEADS

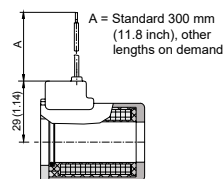

10 LINE ASSEMBLY BODY

LINE ASSEMBLY BODY	PORTS
LAB-34-3/38	3/8" BSP

MATERIAL	MASS
Aluminium Alloy	0,48 kg

