

3 TECHNICAL DATA

Nominal flow rate	32 l/min	Electric characteristics: Those solenoid operated valves are normally equipped by coils type B02, which are energized: directly from a D.C. voltage supply V 12 DC = 012C V 24 DC = 024C by the use of coils that incorporate a full wave bridge rectifier, from A.C. voltage supply : V 110/50 - V 115/60 = 115A V 220/50 - V 230/60 = 230A
Maximum rec. flow rate	40 l/min	
Maximum pressure	25 MPa (250 bar)	
Installation and dimensions	see 7	
Duty cycle	ED 100%	
Mass (without coil)	0,22 kg	

4 TYPICAL DIAGRAMS

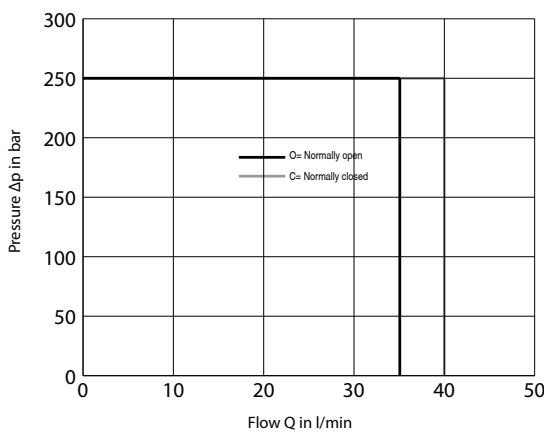

5 HYDRAULIC LIMIT OF USE

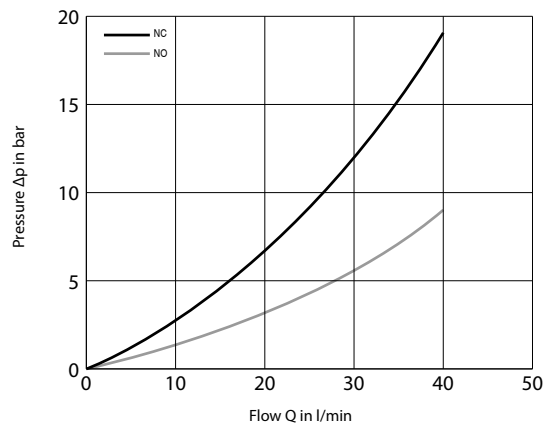

6 CONNECTORS

All connectors must conform to ISO 4400 (DIN 43650) and electric circuitry must be able to carry the following rated current values :

V 12 DC = 2,4 A V 115/50 = 0,26 A

V 24 DC = 1,2 A V 230/50 = 0,14 A

Coils with 2 electric pins, conforming with AMP connectors, are only available for DC supply (example of code : B02-012C AMP).

8 VARIANTS OF MANUAL OVERRIDE

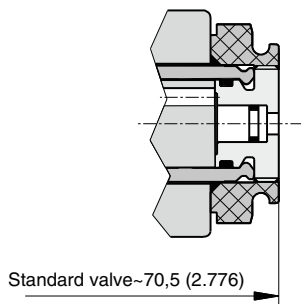

7 INSTALLATION DIMENSIONS

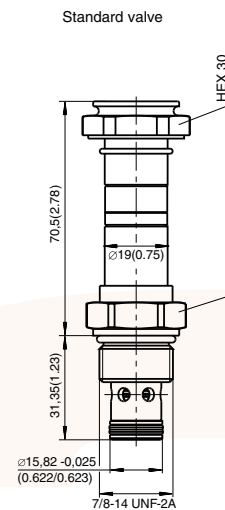

EV2*.78 valves are to be installed in cavity 7/8" 14 UNF . Check the appropriate state and position of the seals, screw the valve in the cavity and lock it with a torque of about 40 Nm applied on the 27 mm hexagon.

9 COILS TYPE B02 (Ø 19mm)

DIN 4365/A-ISO 4400

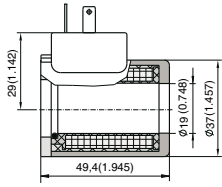

AMP (Amp Junior Timer)

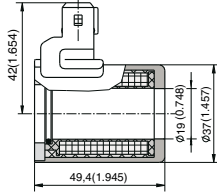

AMPX (Amp Junior Axial)

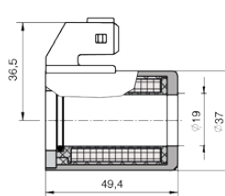

Deutsch

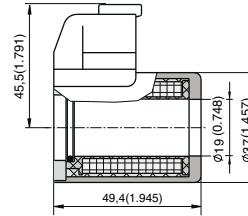

**DIN 4365/A-ISO 4400
With Built-in rectifier**

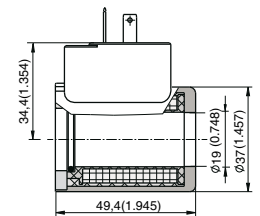

10 LINE ASSEMBLY BODY

LAB-78-2/38, 3/8" BSP, Alluminium Alloy, Mass 0,54 Kg

