

37 mm COIL SERIES

C37 COILS

Ø 16 mm - 26 W

1 DESCRIPTION

- Magnetic circuit encapsulated with thermoplastic resins.
- Standard colour black.
- Metallic parts protected against oxidation.

2 ORDERING CODE

(1)	(2)	(3)
C37	-	-

(1) C38: Coil type

(2) Electric voltages:

- 012C
- 024C
- 024R
- 048R
- 110R
- 220R

(3) Connections:

- no designations: DIN 43650/A
- C: flying leads
- K: Kostal M27x1
- A: AMP Junior

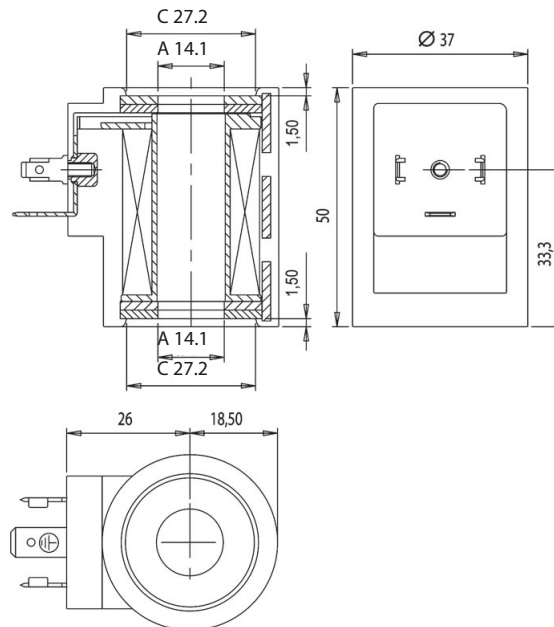

3 TECHNICAL DATA

Typical nominal voltages	- 12-24VDC - 24-110-220RAC
Class H coil as from the IEC	85 standard
Class H wire	200°C
Duty cycle	ED 100% code, voltages, currents and power consumption.
see table for coils:	012C, 024C, 048C for VDC 024R, 110R, 220R for RAC (rectified alternate current)

4 CONNECTION OPTIONS

DIN 4365/A-ISO 4400 DEUTSCH FLYING LEADS AMP JUNIOR

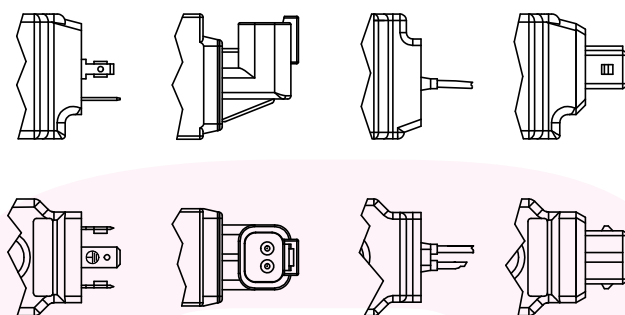

5 TECHNICAL DATA

Coil with ISO/DIN connector	voltage DC	nominal current (A)	resistance cold (Ω)	nominal power (W)	insulation class
C37-012C	V 12 DC	2,2	5,6	26	H
C37-024C	V 24 DC	1,1	22,2	26	
C37-024R	V 24 RAC	1,2	18	26	
C37-048C	V 48 DC	0,5	88	26	
C37-110R	V 110-115 RAC	0,3	380	26	
C37-220R	V 220-230 RAC	0,15	1500	26	