

DIRECT OPERATED CHECK VALVES

AM3-CO-*/25

50 l/min - 32 MPa (320 bar)

1 DESCRIPTION

Direct operated check valve. All the internal part are made with high strenght steel and are machined with accuracy in order to assure the requested tightness. The controlled lines are P, T or PT. The standard surface treatment of the body is phosphate coated. Plugs are zinc coated.



2 ORDERING CODE

(1)	(2)	(3)	(4)	(5)	(6)		
AM3	-	CO	-	/	-	/	25

(1) AM3: stackable valve CETOP 03 - Pressure 32 MPa (320 bar)

(2) CO: check valve. spring operated

(3) Service lines where the controls operate:

T: checks on T: flow T1->T is blocked, free on A, B and P

P: check on P: flow P-> P1 is blocked, free on A, B and T

PT : check on P and T: P-> P1 and T1-> T are blocked, free on A and B

(4) check valve opening (cracking) pressure (Pm):

no designation (standard): Pm approx 0.2 MPa (2 bar)

05: Pm approx 0,05 MPa (0,5 bar)

30: Pm approx 0,3 MPa (3 bar)

50: Pm approx 0,5 MPa (5 bar)

(5) Code reserved for option and variants

V: viton seals

(6) Design number (progressive) of the valves

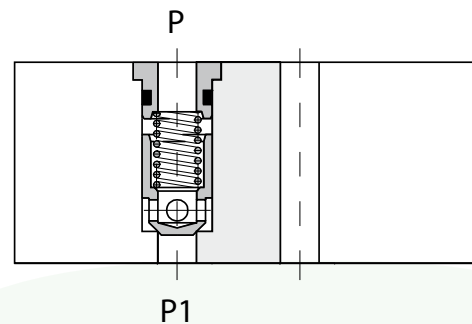
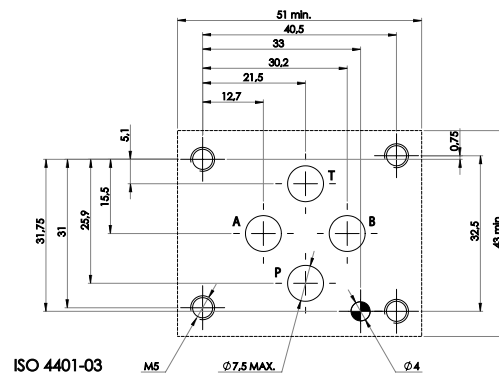

AM3-CO-T-**-**/25

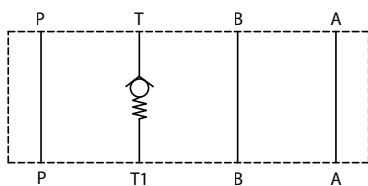

AM3-CO-PT-**-**/25

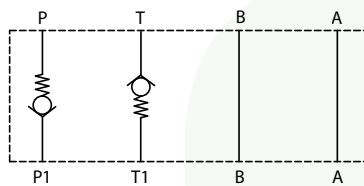

AM3-CO-P-**-**/25

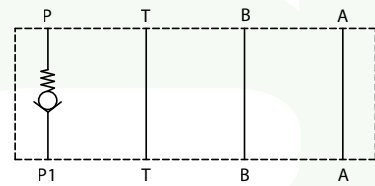

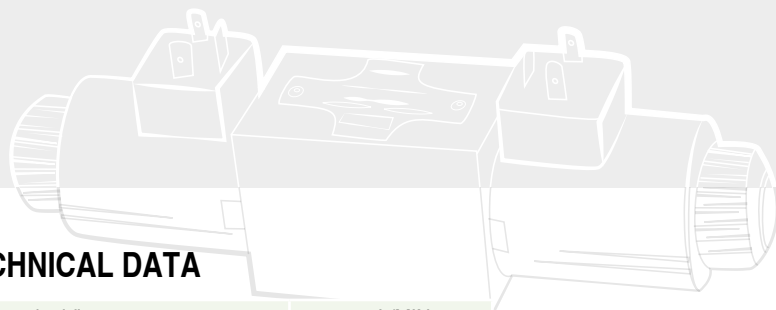

3 TECHNICAL DATA

Maximum nominal flow	50 L/MIN
Maximum rec. flow rate	350 l/min
Maximum nominal pressure	32 MPa (320 bar)
Pressure drops	see 4
Installation and dimensions	see 5
Mass	approx 0,9 kg

4 TYPICAL DIAGRAMS

Typical Δp -Q curves for valves AM3-CO in standard configuration, with mineral oil at 36 cSt and at 50°C

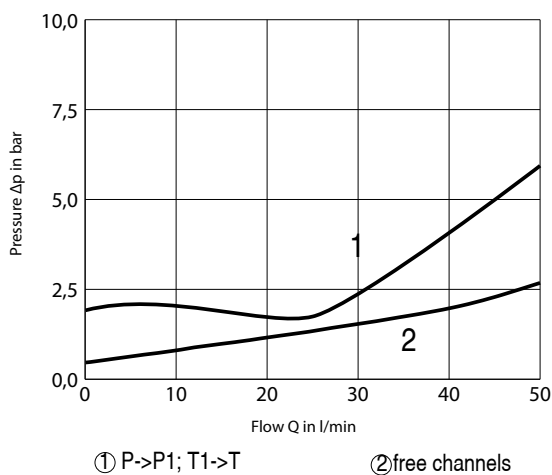

① P->P1; T1->T

② free channels

5 INSTALLATION DIMENSIONS (mm)

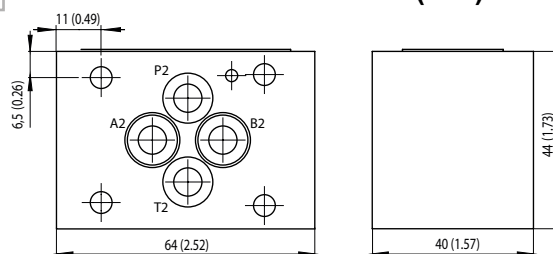

All stackable valves AM3-CO-*/25 conform with ISO and CETOP specifications for mounting surface dimensions. Valves height 40 mm. Leakage between valve and mounting surface is prevented by the positive compression on their seats of 4 seals. All valves have on their "mounting" surface a ϕ 3.4 mm cylindrical hole and have on their "seals" surface a ϕ 3 mm cylindrical hole, conform with ISO and CETOP norms.

6 HYDRAULIC FLUIDS

Seals and materials used on standard valves AM3-* are fully compatible with hydraulic fluids of mineral oil base, upgraded with antifoaming and antioxidantizing agents. The hydraulic fluid must be kept clean and filtered to ISO 4406 class 19/17/14, or better, and used in a recommended viscosity range from 10 cSt to 60 cSt.