

4/2 and 4/3 WAY DIRECTIONAL CONTROL VALVES PILOT OPERATED HD8-*

600 l/min 32 MPa (320 bar)

1 DESCRIPTION

Valves HD8-ES are directional control valve pilot operated with subplate mounting interface acc. to ISO 4401-08, DIN 24340 (CETOP 08 - NG25).

The body is made with an high quality casting.

The CETOP 3 pilot valve is available with interchangeable metallic DC solenoids, also for AC power supply using a built-in rectifier bridge inside the coil.

In the standard version the valve housing is phosphated.

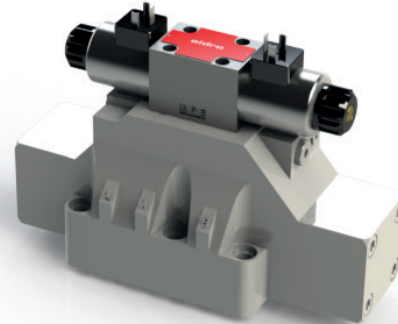

2 ORDERING CODE

(1)	(2)	(3)	(4)	(5)	(6)	(7)
HD8	-	-	/		-	/ 40

(1) HD8: 4-way directional control valve CETOP 07 - Pressure 32 MPa (320 bar)

(2) ES : electrically controlled, standard
HH : hydraulically piloted (main body)

(3) Spool type:

-number is the main spool type

-letter is the solenoid or spring arrangement:

C : 2 solenoids spool is spring centered (3 position)

N : 2 solenoids pilot is detented (2 position)

LL : 1 solenoid (a), spool is spring/hydr. offset (2 position, end to end)

ML : 1 solenoid (a), spool is spring offset (2 position, middle to end)

LM : 1 solenoid (a), spool is spring offset (2 position, end to middle)

b : only for versions LL, MI, LM, see also functional symbols

(4) Code reserved for options and variants

C : adjustable limits for main spool stroke

D : double flow control valve to adjust shifting speed

G : adjustable limits and adjustable shifting speed

P : check valve incorporated in P port of the valve

(5) Pilot and drain arrangement

no designation: internal pilot and external drain (standard)

I : internal pilot and internal drain

E : external pilot and external drain

(6) Electric voltage and solenoid coils

0000 : no coils

012C : coils for V12DC

024C : coils for V24DC

115A : coils for V110/50 - V115/60 AC

230A : coils for V220/50 - V230/60 AC

See also electric characteristic

(7) Design number (progressive) of the valves

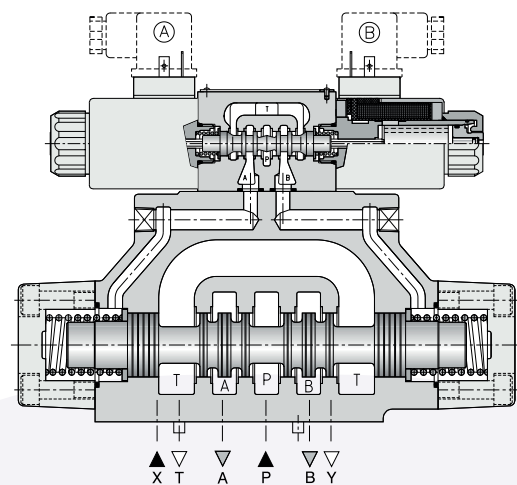
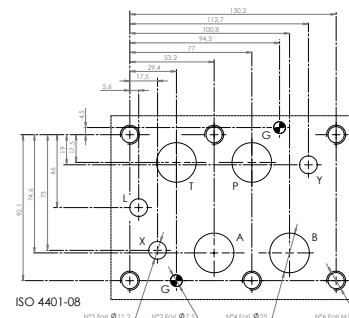

The HD8-ES solenoid operated - hydro-piloted valves are consisting of an HD3-ES type solenoid operated directional control valve (see data sheet HD3-ES) that operates a 4-way hydro-piloted control valve with a connection surface in accordance with the CETOP standards. They are available in various configurations and spool types. The pilot and the drain connections can be made internal or external by inserting or removing the accordant threaded plugs located in the main directional control valve. A wide range of configurations and different solenoid operated-hydro-piloted directional control valve spool positions are available: - 4-way, 3-position directional control valve, with two solenoids; positioning of the spool in center position is obtained with centering springs. - 4-way, 2-position directional control valve with one solenoid; positioning of the spool in center position is determined hydraulically by the pilot valve and mechanically (even without pressure) by the main stage return spring. - 4-way, 2-position directional valve, with two solenoids, with mechanical detent of the shifted pilot spool positions when solenoids are de-energized. The basic surface treatment of the valve housing is phosphate coated and the solenoids are zinc coated.

3 TECHNICAL DATA

Max. recommended flow (spring centering)	400 l/min
Max. recommended flow (hydraulic centering and hydraulic off set)	600 l/min
Max pressure at P, A, B ports	32 MPa (320 bar)
Max pressure at T port (internal drain)	16 MPa (160 bar)
Max pressure at T port (external drain)	25 MPa (250 bar)
Pilot pressure minimum	0,5 MPa (5 bar)
Pilot pressure Max. recommended	20 MPa (200 bar)
Mass:	
HD8-ES	approx. 15,50 Kg
HD8-HH	approx. 14,00 Kg

4 SPOOL IDENTIFICATION AND INTERMEDIATE POSITION TRANSITORIES

1C			67C		
0C			77C		
3C			55C		
4C			56C		
Two positions with return spring					
1LL			35C		
0LL			8C		
1ML			76C		
1LLb			65C		
0LLb					
1MLb					
Two positions with mechanical detent on pilot valve					
1N					
0N					

5 TYPICAL DIAGRAMS

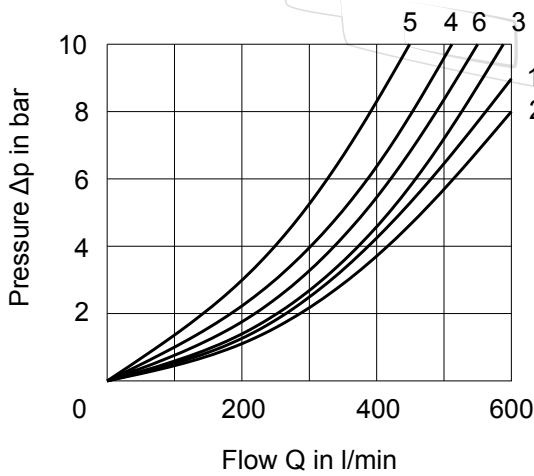

Spool type	Spool position	Connections				
		P-A	P-B	A-T	B-T	P-T
		Curves on graph				
1C	Energized	1	1	2	3	
0C	De-energized Energized	2	2	1	2	6*
3C	De-energized Energized	1	1	4° 1	4° 2	
4C	De-energized Energized	6	6	3	4	5
67C	De-energized Energized	1	4 2	2	3	
77C	De-energized Energized	1	1	2	4 2	
55C	De-energized Energized	6	6	3	4	5°
56C	De-energized Energized	6	6	4	3	5°
35C	Energized	1	1	2	3	
8C	De-energized Energized	4° 2	4° 2	2	3	
76C	De-energized Energized	1	1	3 1	3	
65C	De-energized Energized	4 2	1	2	3	
1LL,OLL, 1ML	De-energized Energized	1	1	2	3	
1N,ON	Energized	1	1	2	3	

6 INSTALLATION DIMENSION

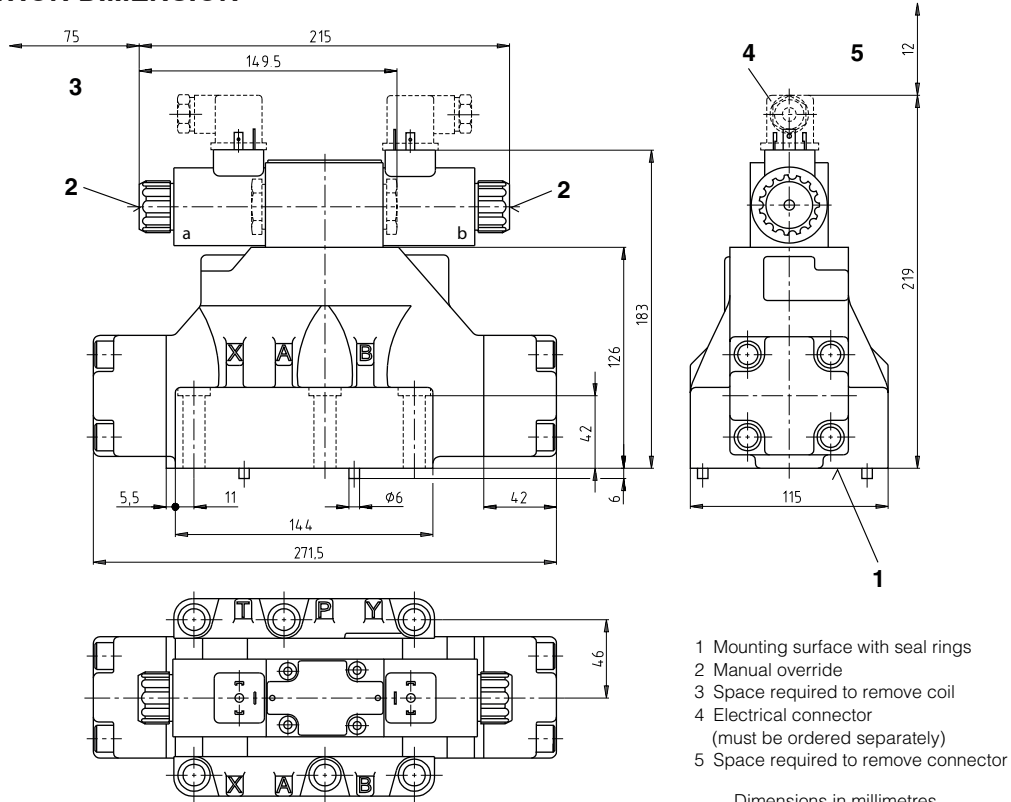

- 1 Mounting surface with seal rings
- 2 Manual override
- 3 Space required to remove coil
- 4 Electrical connector
(must be ordered separately)
- 5 Space required to remove connector

Dimensions in millimetres

Single valve fastening:	6 bolts M12 x 60 *
Bolt torque:	69 Nm - bolts A 8.8; 1155 Nm - bolts A 12.9
Threads of mounting holes:	M12 x 20
Seal rings:	4 O-rings type 29.82 x 2.62 2 O-rings type 20.24 x 2.62

7 TYPE OF COMMAND

Solenoid control: HD8-ES

The valve is supplied with a pilot solenoid valve type HD3-ES.

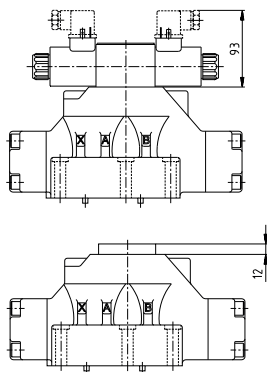

Hydraulic control: HD8-HH

The valve is supplied as main body.

X and Y connections are used for the hydraulic control of the valve.

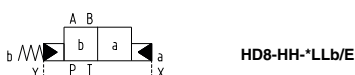
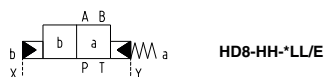
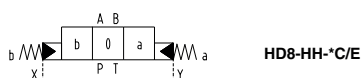

8 CONTROLS

Control of the main spool stroke: C

It is possible to introduce special stroke controls in the heads of the hydropiloted valve so as to vary the maximum spool stroke. This solution allows control of the flow rate from the pump to the actuator and from the actuator to the outlet, obtaining a double adjustable control on the actuator. Add the letter **C** to the identification code to request this device.

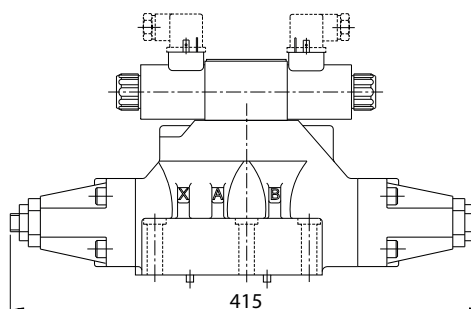

Control of the main spool shifting speed: D

By placing a double flow control valve between the pilot solenoid valve and the hydropiloted valve, the piloted flow rate can be controlled and therefore the shifting speed can be varied. Add the letter **D** to the identification code to request this device.

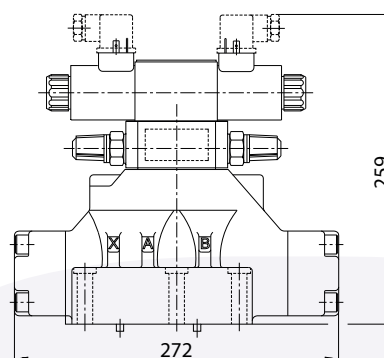

Control of the main spool stroke and shifting speed: G

It is possible to have the valve fitted with both the spool stroke device and the piloting flow rate control device. Add the letter **G** to the identification code to request this solution.

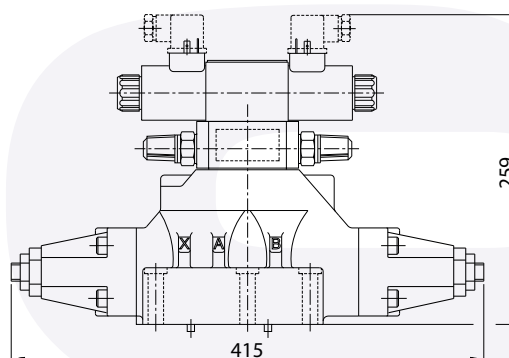

9 SPECIAL CONFIGURATION

Solenoid valves with special spools

Besides the standard configurations (see pages 2 and 3), we can develop, on request, connection diagrams with special spools for a wide range of applications: consult our technical department for their identification, feasibility and operating limits.

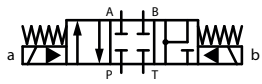

19C

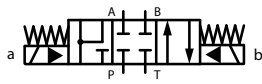

18C

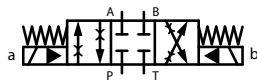

15C

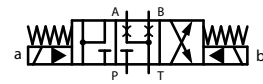

38C

Check valve incorporated on line P: P

Valve HD8 is available upon request with check valve incorporated on line P. This is particularly useful to obtain the necessary piloting pressure when the main control valve, in the rest position, has line P connected to the T outlet. The cracking pressure is 5 bar. Add P to the identification code for this request.

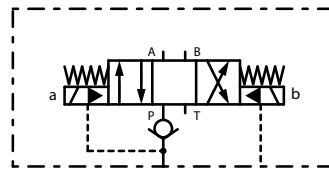

10 PILOT and DRAIN

The HD8 valves are available with pilot and drain, both internal and external. The version with external drain allows for a higher back pressure on the outlet.

Type of valve		Plug assembly	
		X	Y
HD8-ES-**/*	Internal pilot and external drain	NO	YES
HD8-ES-**/*I	Internal pilot and internal drain	NO	NO
HD8-ES-**/*E	External pilot and external drain	YES	YES
HD8-ES-**/*EI	External pilot and internal drain	YES	NO

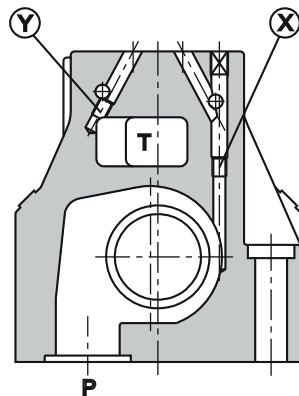

X: plug 1/16 NPT for external pilot
Y: plug M6 x 8 for external drain