



SCREW-IN, 3-WAY SOLENOID OPERATED DIRECTIONAL VALVE CAVITY 7/8" 14 UNF-SAE 10/3 spool type EV3*.78.*

40 l/min 25 MPa (250 bar)

1 DESCRIPTION

Directional control valve 3 way 2 position spool type. Is possible to have this valve in different spool configurations. On demand a high performance version is available in case of higher flow rates or pressure. The dual seals rings assure an efficient and reliable tightness of the valve.

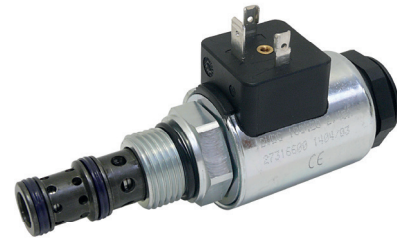

2 ORDERING CODE

(1)	(2)	(3)	(4)	(5)	(6)	(7)
EV3	-	78	-	-	-	/

(1) EV3 : 3-way solenoid operated spool type

(2) Spool type

C : normally closed
O : normally open

(3) 78 : cavity 7/8" 14 UNF

(4) Valves variants (see 7)

03 : without manual override
04 : manual override push type (standard)
05 : manual override screw type

(5) Electric voltage and solenoid coils (see 9)

0000 : no coils
012C : coils for V12DC
024C : coils for V24DC
115A : coils for V110/50 – V 115/60 AC
230A : coils for V220/50 – V 230/60 AC

(6) Options for coil connection

no designation : standard connection ISO4400/DIN43650/A
D:Deutsch;
A: AMP Junior Timer;
AMPX

(7) Design number (progressive) of the valves

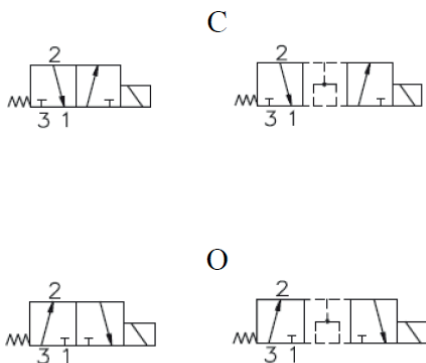

Recommended use of ports: 3=P; 1=T

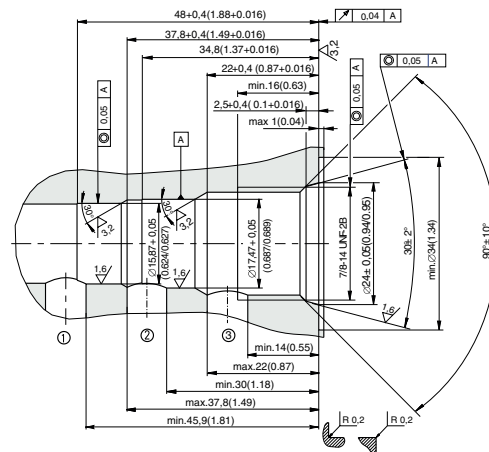

Standard performance

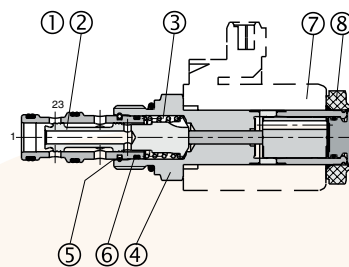

Screw-in 3/2 solenoid valves type EV3*.78 are composed by a valve sleeve 1, a control spool 2, a return spring 3, and an actuating assembly 4 that comprises the magnetic parts and the screwing section. An energizing electric solenoid coil 5 is fastened to the assembly by means of a retaining nut 6. When solenoid coils is energized, a magnetic mobile armature shifts and by means of a rod installed inside assembly, moves the control spool which makes hydraulic connections between 1,2,3 ports.

3 TECHNICAL DATA

Nominal flow rate	32 l/min	Electric characteristics:
Maximum rec. flow rate	40 l/min	Those solenoid operated valves are normally equipped by coils type B02, which are energized directly from a D.C. voltage supply
Maximum pressure	25 MPa (250 bar)	V 12 DC = 012C
Installation and dimensions	see 8	V 24 DC = 024C
Duty cycle	ED 100%	by the use of coils that incorporate a full wave bridge rectifier, from A.C. voltage supply :
Mass (without coil)	0,24 kg	V 110/50 - V 115/60 = 115A
		V 220/50 - V 230/60 = 230A

4 TYPICAL DIAGRAMS

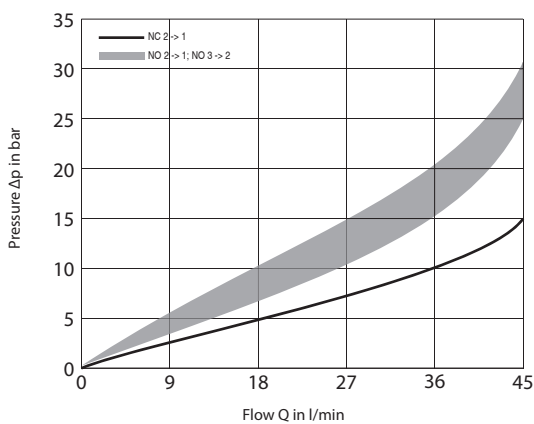

5 HYDRAULIC LIMIT OF USE

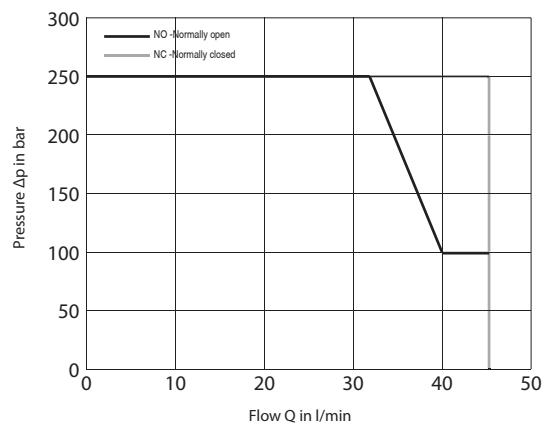

6 CONNECTORS

All connectors must conform to ISO 4400 (DIN 43650) and electric circuitry must be able to carry the following rated current values :

V 12 DC = 2,4 A V 115/50 = 0,26 A

V 24 DC = 1,2 A V 230/50 = 0,14 A

Coils with 2 electric pins, conforming with AMP connectors, are only available for DC supply (example of code : B02-012C AMP).

7 VARIANTS OF MANUAL OVERRIDE

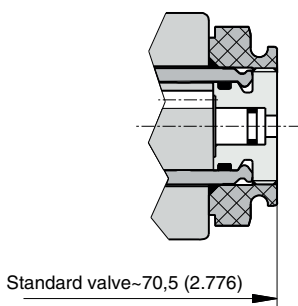

8 INSTALLATION DIMENSIONS

Standard valve

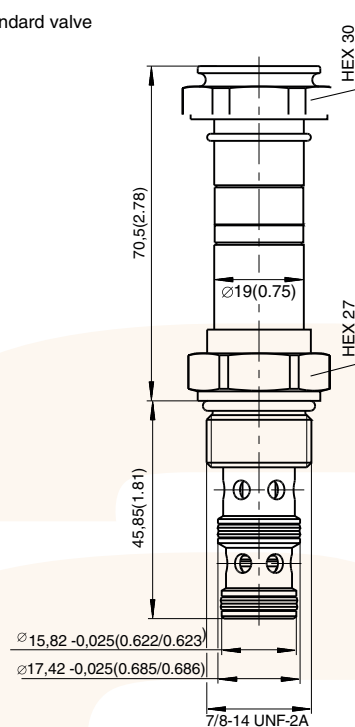

EV3*.78 valves are to be installed in cavity 7/8" 14 UNF . Check the appropriate state and position of the seals, screw the valve in the cavity and lock it with a torque of about 40 Nm applied on the 27 mm hexagon.

9 COILS TYPE B02 (Ø 19mm)

DIN 4365/A-ISO 4400

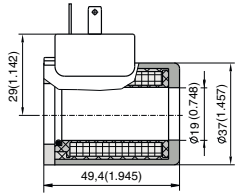

AMP (Amp Junior Timer)

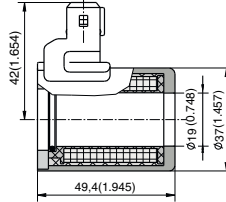

AMPX (Amp Junior Axial)

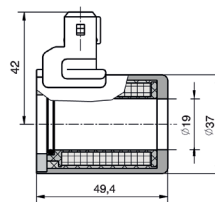

Deutsch

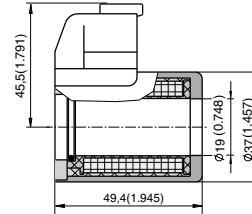

DIN 4365/A-ISO 4400
With Built-in rectifier

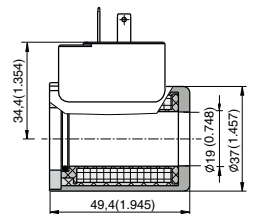

10 LINE ASSEMBLY BODY

LAB-78-3/38, 3/8" BSP, Alluminium Alloy, Mass 0,60 Kg

