

## STACKABLE VALVES FLOW CONTROL

### AM5-FC-\*

100 l/min 32 MPa (320 bar)

#### 1 DESCRIPTION

Stackable valve CETOP 5 with meter out control (referred to the hydraulic actuator). It is possible to control the lines A, B or AB simply turning the side screws.

On demand it is possible to have also the fine control option.



#### 2 ORDERING CODE

| (1) | (2) | (3) | (4) | (5) | (6)  |
|-----|-----|-----|-----|-----|------|
| AM5 | -   | FC  | -   | -   | / 10 |

(1) AM5 : stackable valve CETOP 05 - Pressure 32 MPa (320 bar)

(2) FC : one-way flow control valves with meter-out control (referred to the hydraulic actuator)

(3) Service lines where the controls operates:  
 AB : controls on A and B. Fluid flows unrestricted A->A1 and B->B1;  
 flow is controlled from A1->A and B1->B.  
 A : flow is controlled from A1->A; free on B.  
 B : flow is controlled from B1->B; free on A.

(4) flow control characteristics for A1->A and B1->B  
 and check valve opening pressure (Pm) for flow A ->A1 and B->B1  
 no designation : standard control and Pm approx 0.04 MPa (0.4 bar)  
 V : fine control  
 4 : Pm approx 0.4 MPa (4 bar)

(5) Code reserved for special variants

(6) Design number (progressive) of the valve

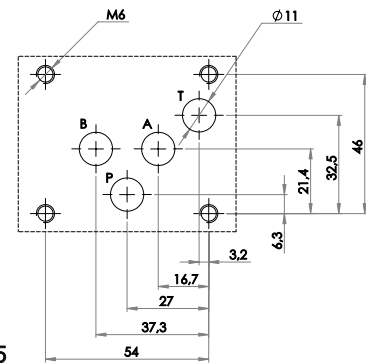

ISO 4401-05

AM5-FC-AB

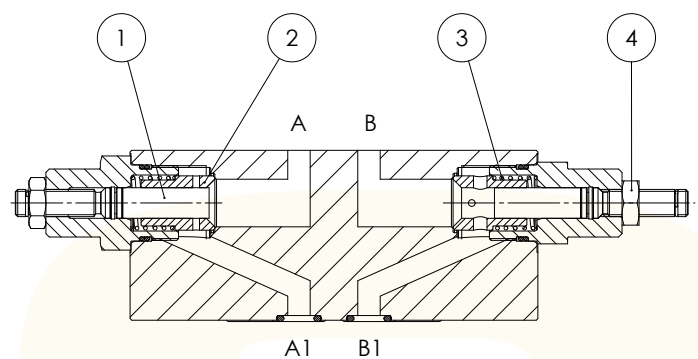

Fluids flows freely on P and T lines: on service lines A and/or B with controls, fluid flows from A -> A1 (and/or B-> B1) overcoming the force of spring 3 acting on sleeve 2; fluid flows from A1-> A (and/or B1->B) through orifices to sleeve 2 which is pushed against its seat; the throttling axis 1, which is shifted by screwing it and locked by its nut 4, partially obstructs the control orifices, thus making the flow rate entirely dependent upon the available pressure drop.

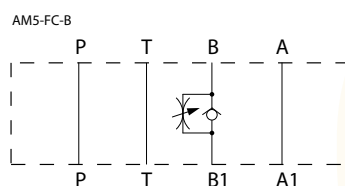
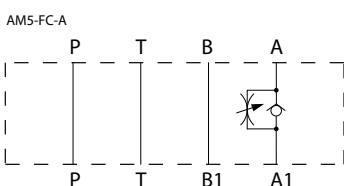
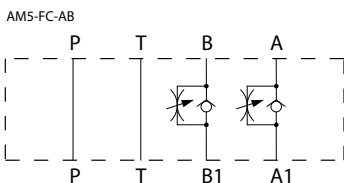

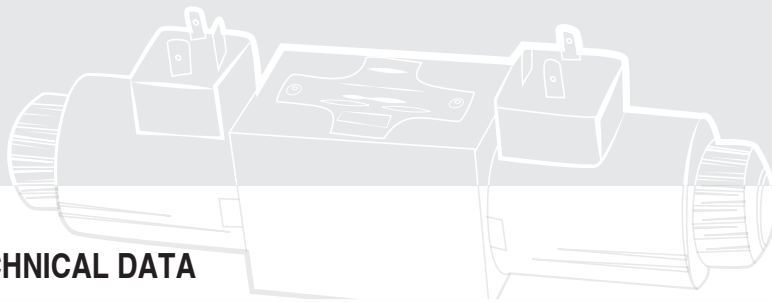

### 3 TECHNICAL DATA

|                             |                  |  |
|-----------------------------|------------------|--|
| Maximum rec. flow rate      | 100 l/min        | Control of the flow:<br>The control is made by throttling from A1->A (and/or B1->B), through variable orifices. Depending on the various sleeve/axis combination, the control adjustment is:<br>- (standard) : orifices area is reduced from 100% (*) to 0% with 6 complete turns of the adjustment screw.<br>-V (fine): from 100% (**) to 0% with 5 complete turns of the adjustment screw.<br>(* ) 100% approx: Q=60 l/min at p=20 bar<br>(**) 100% approx : Q=30 l/min at p=20 bar<br>The axis is shifted to increase throttling by unlocking its nut and turning clock wise the adjustment screw. Suitable mechanical stops prevent dangerous manoeuvring. |
| Maximum nominal pressure    | 32 MPa (320 bar) |  |
| Pressure drops              | see 4            |  |
| Installation and dimensions | see 6            |  |
| mass                        | approx 3 kg      |  |

### 4 TYPICAL DIAGRAMS

Typical  $\Delta p$ -Q curves for valves AM5-FC-AB in standard configuration, with mineral oil at 36 cSt and at 50°C with throttling axis at full retraction.

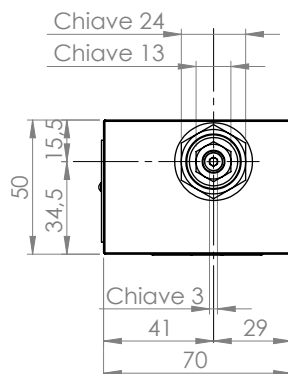
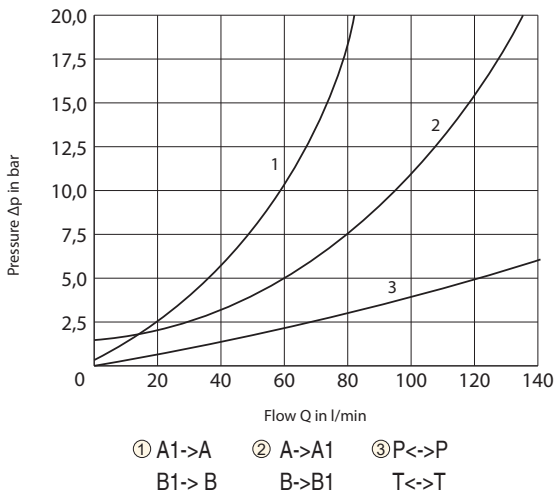

All stackable valves AM5-FC-\* conform with ISO and CETOP specifications for mounting surface dimensions (see also front page). Valves height 50 mm. Leakage between valve and mounting surface is prevented by the positive oppression on their seats of 4 seals of OR type or Quading type.

### 5 HYDRAULIC FLUIDS

Seals and materials used on standard valves AM5-\* are fully compatible with hydraulic fluids of mineral oil base, upgraded with antifoaming and antioxidantizing agents. The hydraulic fluid must be kept clean and filtered to ISO 4406 class 19/17/14, or better, and used in a recommended viscosity range from 10 cSt to 60 cSt.

### 6 INSTALLATION DIMENSIONS

