

STACKABLE CHECK VALVES

AM2-CO-*/10

30 l/min - 32 MPa (320 bar)

1 DESCRIPTION

Direct operated check valve. All the internal part are made with high strenght steel and are machined with accuracy in order to assure the requested tightness. The controlled lines are A, B or AB. The standard surafce treatment of the body is phosphate coated. Plugs are zinc coated.



2 ORDERING CODE

(1)	(2)	(3)	(4)	(5)	(6)	
AM2	-	CO	-	-	/	10

- (1) AM2: stackable valve CETOP 02- Pressure 32MPa (320bar)
- (2) CO: check valve, spring operated
- (3) Service lines where the controls operate:
 - AB : checks on A and B. Fluid flows A -> A1 and B -> B1 and cannot flow A1->A, B1->B, free on P and T
 - A : check on A: flow A1 -> A is blocked, free on B,P and T
 - B : check on B: flow B1 -> B is blocked, free on A,P and T
- (4) Check valve opening (cracking) pressure (Pm):
 - no designation: Pm approx 0,2MPa (2bar)
 - 4: Pm approx 0,4MPa (4bar)
- (5) Code reserved for special variants (materials, seals, surface treatments etc.).
- (6) Design number (progressive) of the valves

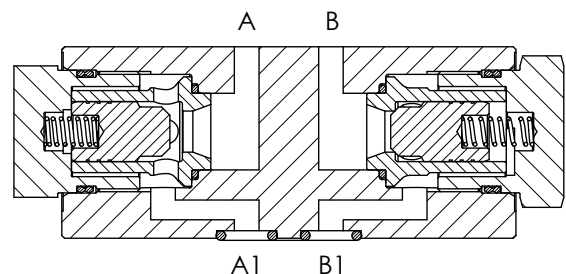
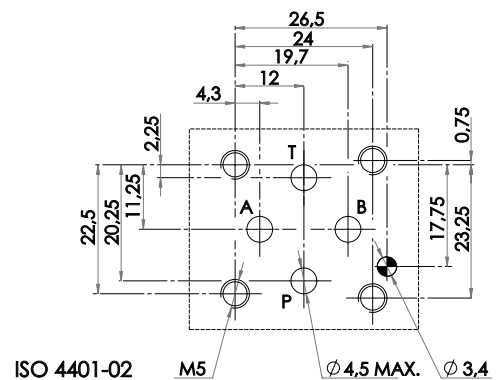

Fluid flows freely on P and T lines; on service lines A and/or B with controls, fluid flows from A -> A1 (and/or B -> B1) overcoming the force of spring acting on sleeve ; fluid flows from A1 -> A (and/or B1 -> B) through orifices of sleeve which is pushed against its seat; the throttling axis which is shifted by screwing it and locked by its nut , partially obstructs the control orifices, thus making the flow rate entirely dependent upon the available pressure drop.

AM2-CO-AB

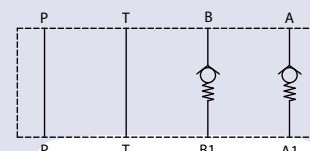

AM2-CO-A

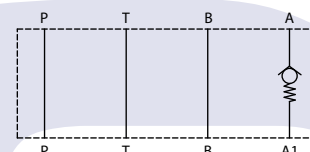

AM2-CO-B

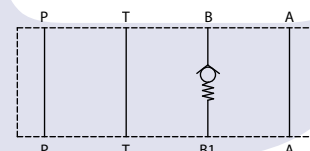

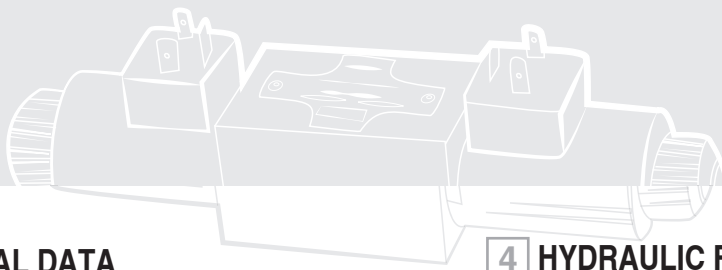

3 TECHNICAL DATA

Maximum rec. flow rate	30 l/min
Maximum nominal pressure	32 MPa (320 bar)
Pressure drops	see 5
Installation and dimensions	see 6
Mass	approx 0,75 kg

4 HYDRAULIC FLUIDS

Seals and materials used on standard valves AM2-* are fully compatible with hydraulic fluids of mineral oil base, upgraded with antifoaming and antioxidantizing agents. The hydraulic fluid must be kept clean and filtered to ISO 4406 class 19/17/14, or better, and used in a recommended viscosity range from 10 cSt to 60 cSt.

5 TYPICAL DIAGRAMS

Typical Δp -Q curves for valves AM2-CO in standard configuration, with mineral oil at 36 cSt and at 50°C.

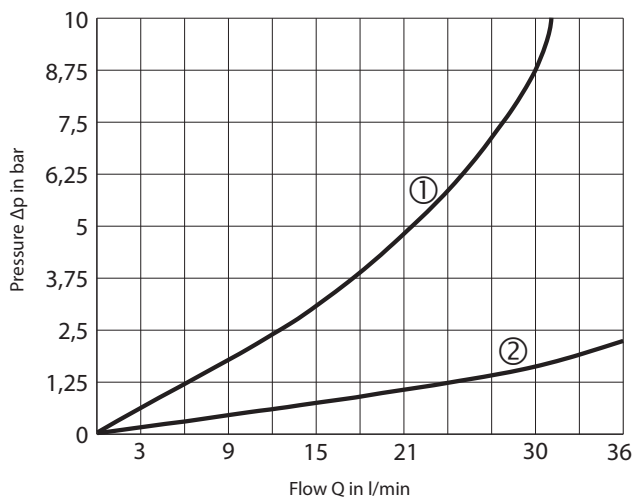

- ① A -> A1
B -> B1
- ② Free channels

6 INSTALLATION DIMENSIONS (mm)

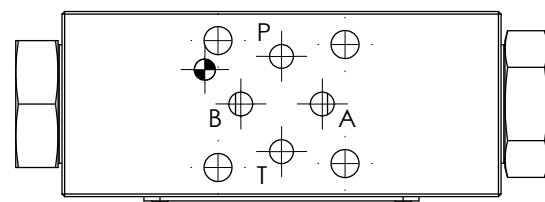
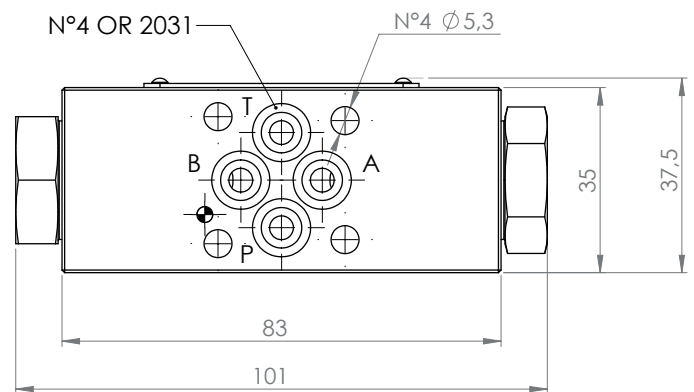

All stackable valves AM2-CO-* conform with ISO and CETOP specifications for mounting surface dimensions (see also front page). Valves height 35 mm. Leakage between valve and mounting surface is prevented by the positive compression on their seats of 4 seals of OR type. All valves have on their "mounting" surface a \varnothing 4 mm cylindrical hole and have on their "seals" surface a \varnothing 3 mm cylindrical hole, conform with ISO and CETOP norms.